

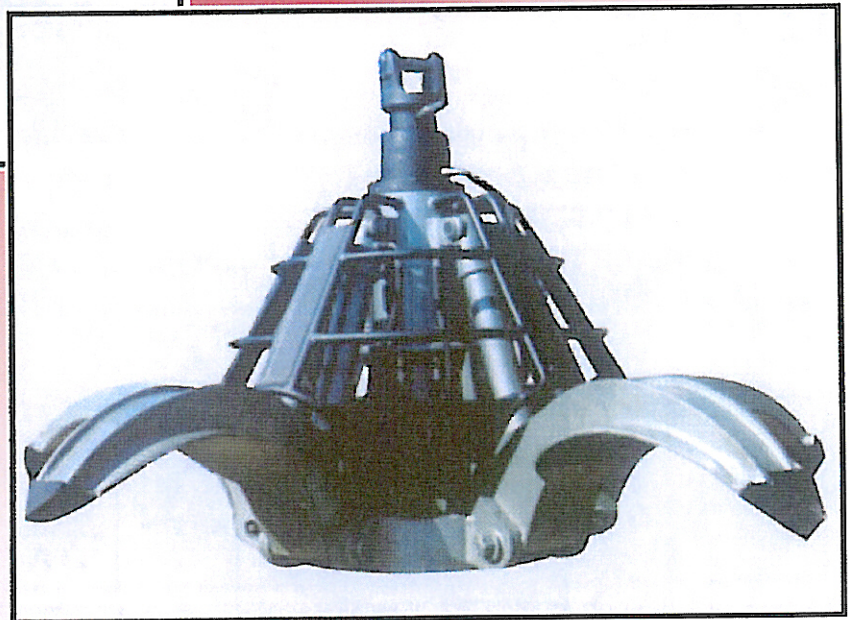

ATLAS HIDRAULICA

PULPO HIDRÁULICO MOD. PHE 1-4000-220-820 CON ELECTROIMÁN

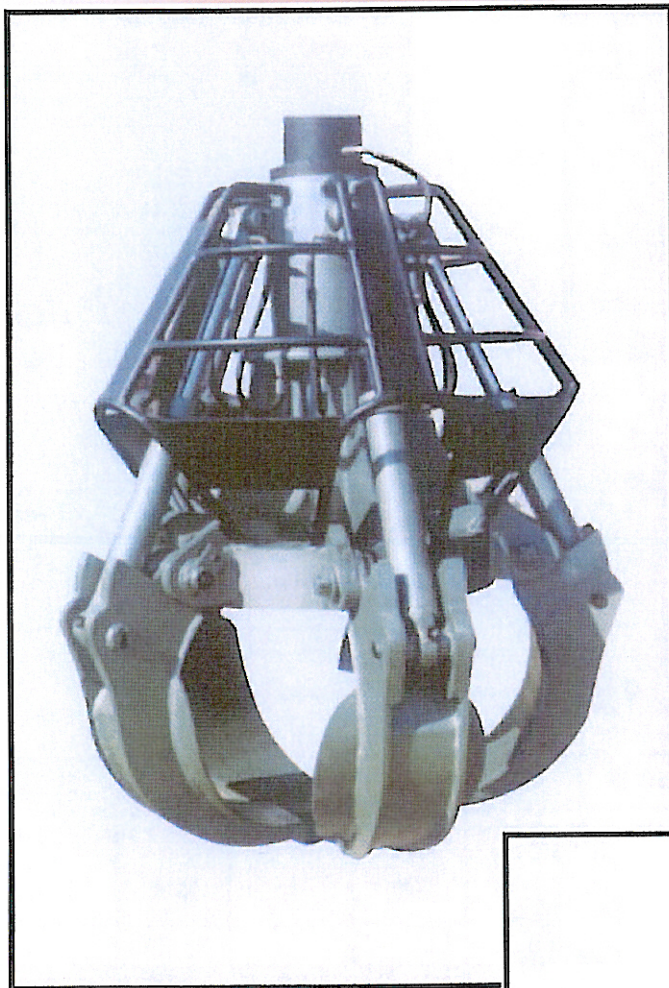

Avda. Antoni Gaudí, 71-109, Nave 1, 08191 RUBÍ (BARCELONA)
902 20 20 92
Ctra. C-17, Km 50, 08550 TONA (BARCELONA)

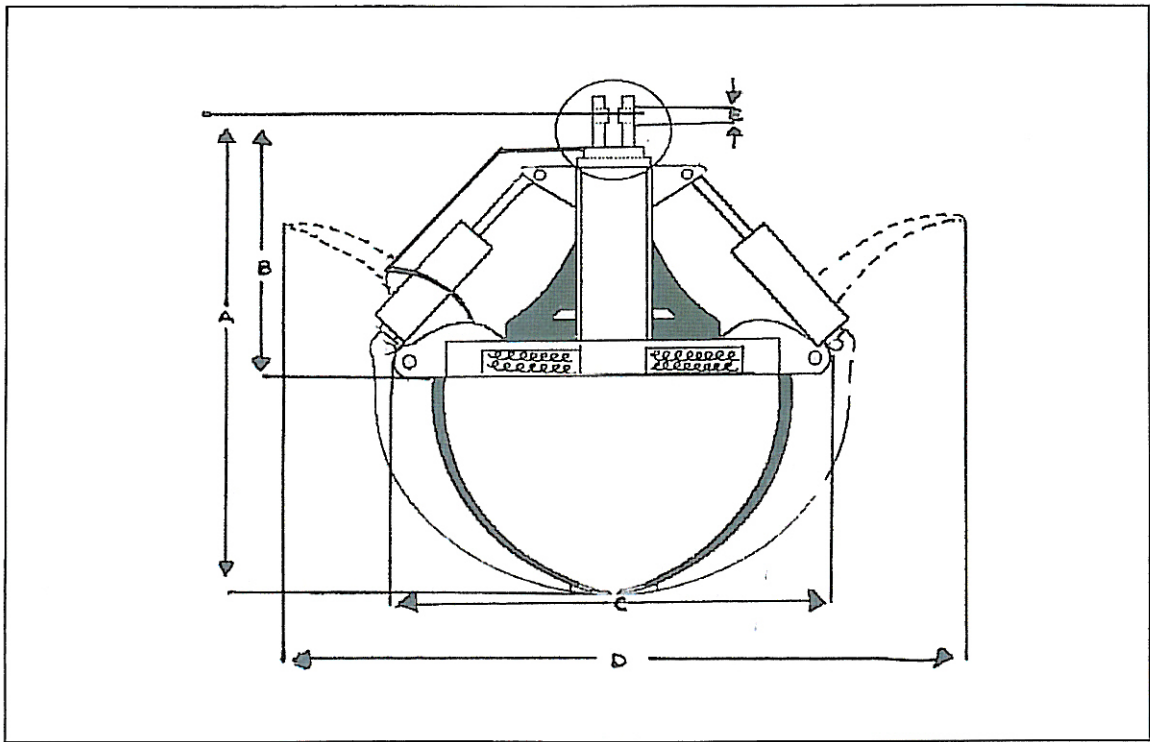

SE PUEDE ADAPTAR:

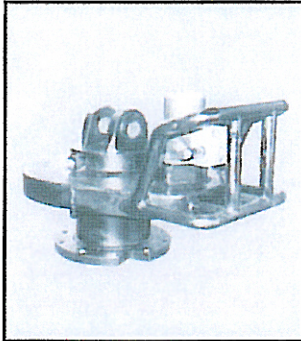

GIRO CONTROLADO
CON MOTOR
HIDRÁULICO

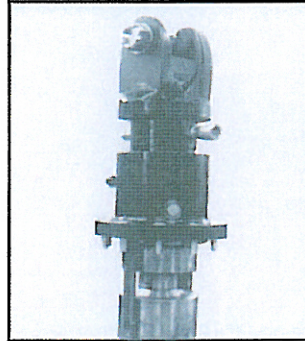



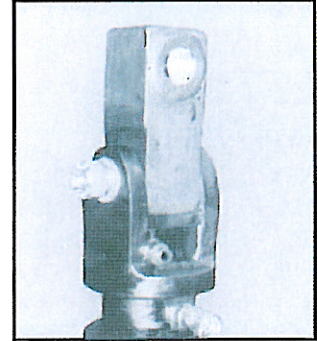



GIRO
LOCO
CON COLECTOR



DADO DE
ACOPLE

CARACTERÍSTICAS • TECHNISCHE DATEN • SCRAP HANDLER • CARACTERISTIQUES

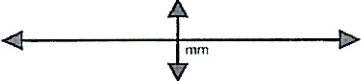
												
						Ø A	Ø B	C	D	Ø E	Ø F	G
PHEG 1-4000- 220-820	500	350	4/5	1.600	1.800	2.400	1.400	1.100	2.300	45	820	

NOTA: SE PUEDE FABRICAR CON 6 GARRAS

Avda. Antoni Gaudí, 71-109, Nave 1, 08191 RUBÍ (BARCELONA)
902 20 20 92
Ctra. C-17, Km 50, 08550 TONA (BARCELONA)